

CyberGage360™

One-Button Automation for 3D Scan Inspection.

3D SCANNERS

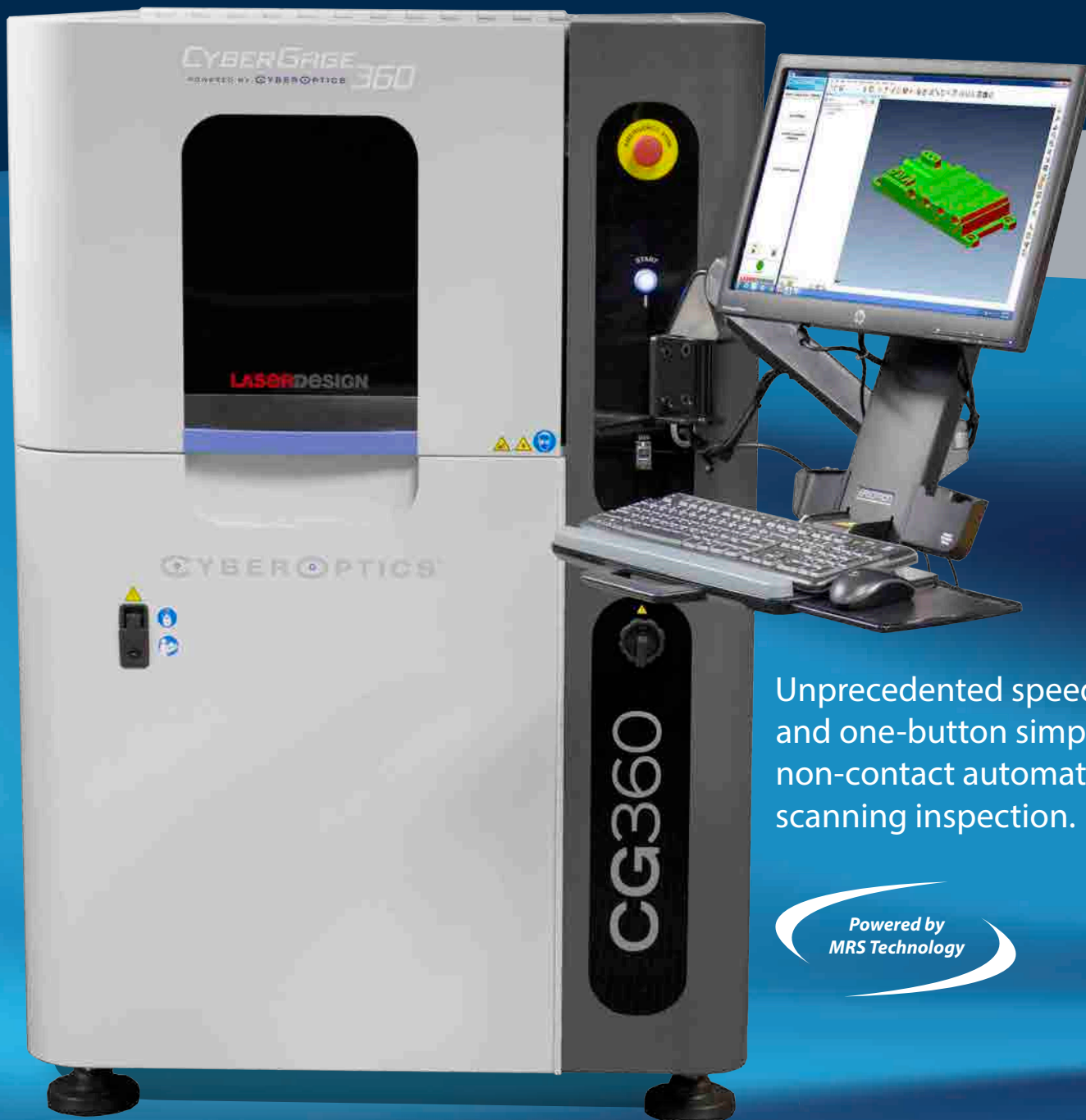

Unprecedented speed, accuracy and one-button simplicity for non-contact automated 3D scanning inspection.

Powered by
MRS Technology

CyberGage360™

Powered by
MRS Technology

High Precision Accuracy with Multi-Reflection Suppression (MRS) Sensor Technology

The CyberGage360 is a blue light 3D Scanning System powered by CyberOptics' breakthrough, patented 3D scanning technology that enables metrology-grade accuracy by inhibiting optical measurement distortion and reflections. CyberOptics' MRS 3D scanning sensor technology is at the heart of the world's cell phone manufacturing inspection systems.

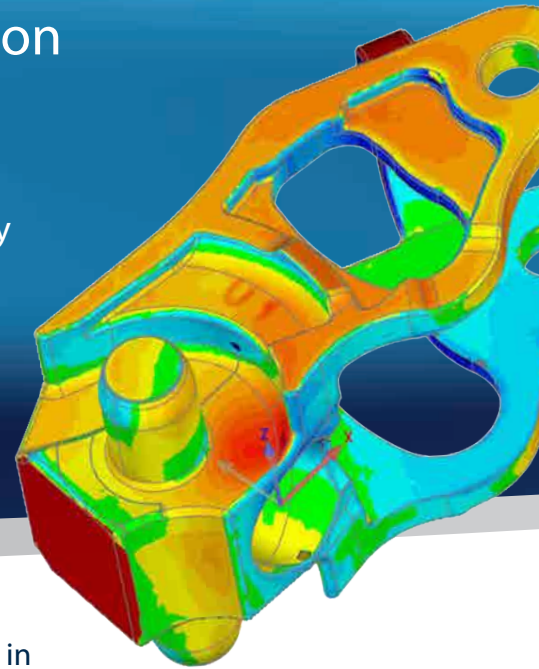

MRS allows simultaneous data capture from multiple sensors and transmits in parallel multiple image data at unprecedented speeds. CyberGage360's patented algorithms combine tremendous amounts of data into a single coordinate system using high-precision encoder position feedback for mechanical metrology-grade part measurement. No best fit piecing together of scan regions is used as is common in competitive projection scanning systems. The resulting part measurement provides NIST traceable system accuracy to $7 \mu\text{m} + L/10000$, and repeatability to $5 \mu\text{m}$.

MRS suppresses the reflections caused by reflective surfaces better than any other projection scanning technology using the patented algorithms and optics born of MRS technology, resulting in a highly precise scan.

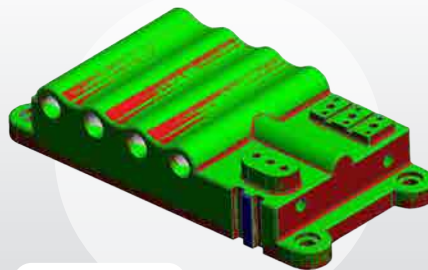
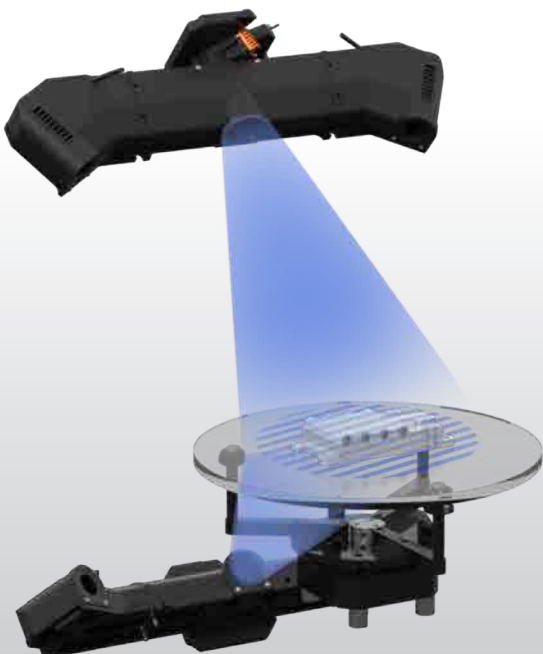

Color Map

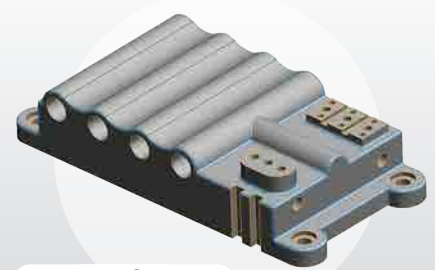

CAD/ Reference

Scan generates high density point cloud data to compare to CAD model or reference part

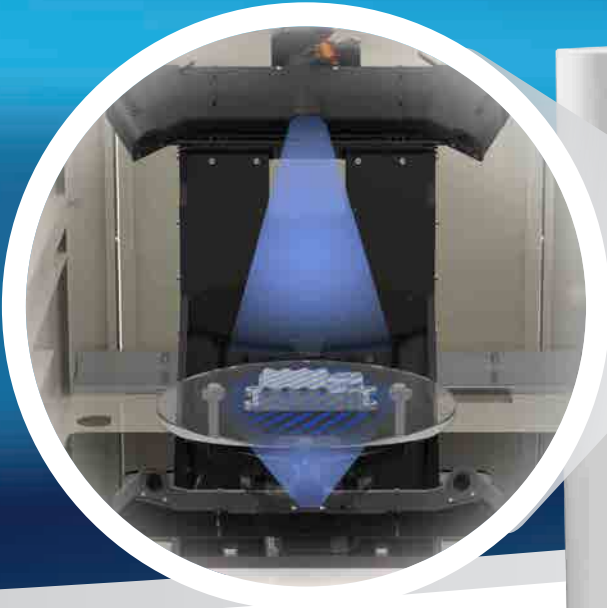

MRS suppresses the effects of variations in surface characteristics of parts under inspection, resulting in a highly precise scan

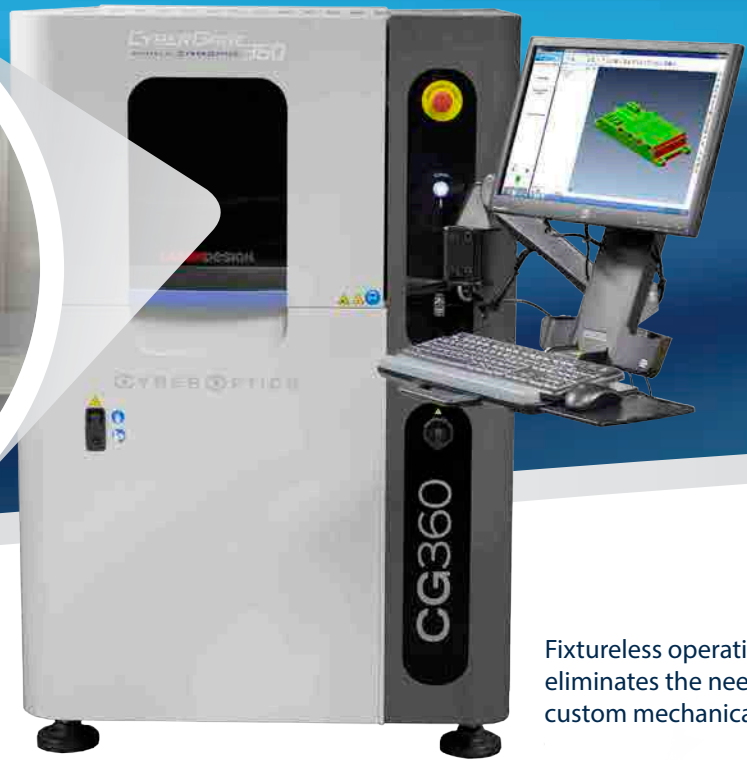

Fixtureless operation eliminates the need for costly custom mechanical gages

CyberGage360 Multiple Scanning Sensor Architecture

The patented CyberGage360 system design utilizes two dual camera optical blue light scanning sensors mounted above and below the subject part sitting on an optically flat, clear glass plate calibrated for scanning. The glass plate allows simultaneous data capture from both sensors and eliminates the need to flip-over the part necessary for all other scanning and other conventional measuring systems. The rugged industrial enclosure provides a stable measuring environment and eliminates the effects of ambient light on the part under measurement. The small footprint of CyberGage360 can be used on the factory floor, in the inspection lab, or for incoming parts inspection.



No Part Fixture Required

No Part Alignment Necessary

Automatic Comparison to CAD

Automated 3D Volumetric Part Scan and Inspection Report in less than 3 minutes

The CyberGage360 dramatically speeds-up part inspection, compared to traditional Coordinate Measuring Machines, and provides a complete volumetric part surface scan with dimensions, GD&T and comparison to CAD in under 3 minutes including impressive part inspection report generation. Software simplicity allows the capture of millions of data points per part position with a typical complex part requiring 6-12 rotary positions to accurately represent part geometry.

CyberGage System Calibration

CyberGage360 is supplied with a NIST traceable calibration artifact. The QR Coded artifact is automatically scanned by CyberGage360 and the system is field-calibrated to ensure the most accurate measurements regardless of changing environment.

3D AOI (Automated Optical Inspection) or Production Gauge - Your Choice

CyberGage can be utilized as a 3D AOI device providing fast and accurate absolute measured data or as a comparative analysis gauge providing production trend and go/no go analysis when measuring a reference part.

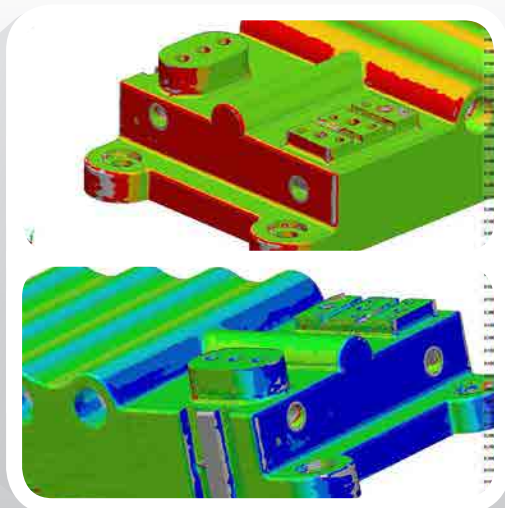
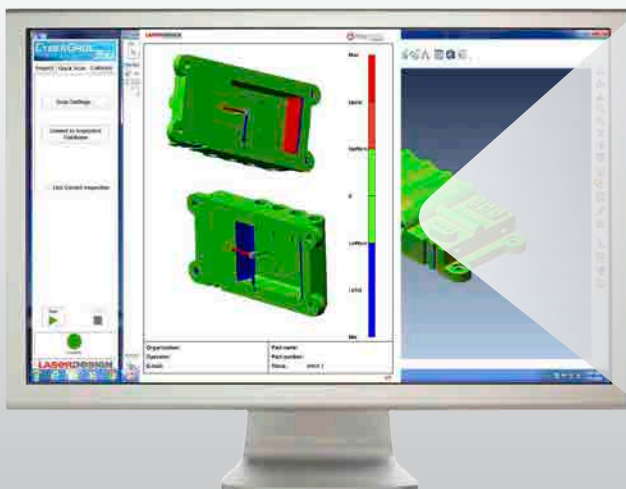

Easy-to-use Software with Push-Button Automation

CyberGage360 provides the easiest user experience for 3D scanning inspection requiring no fixture or part alignment. Open the door, place part on the glass plate and press the button. The system comes standard with bar-code reader allowing for automatic program selection. CyberGage360 requires no specialist training providing factory-friendly shop-floor operation while supplying metrology-grade inspection accuracy.

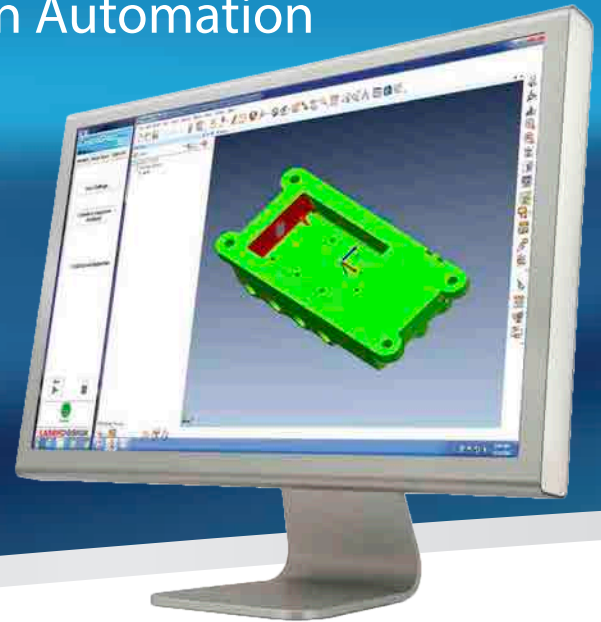

The generated full volumetric scan provides a high density point cloud for automatic alignment to the CAD model or 'golden part' with the embedded industry-standard Polyworks® inspector software technology. CyberGage360 comes complete with the built-in Polyworks software license and factory training.

MRS Technology provides metrology-grade accuracy by inhibiting optical measurement distortions (glints) common in white/blue light scanned data.

Automated Generation of Part Program and Inspection Report from CAD with PMI

The full volumetric part scan generated by CyberGage360 is automatically aligned to the CAD model by Polyworks software. A comprehensive inspection report including dimensions and GD&T is generated automatically using PMI (Production Manufacturing Information) if contained within the CAD part model. Critical part inspection criteria are tracked automatically by trend analysis/ SPC. A 3D color deviation map is displayed indicating tolerance variation as compared to CAD. Red or blue indicate oversize/undersize condition. Inspection projects can be digitally shared throughout a manufacturing organization, suppliers and customers using the free Polyworks Inspection Viewer providing rapid access to critical geometric data.

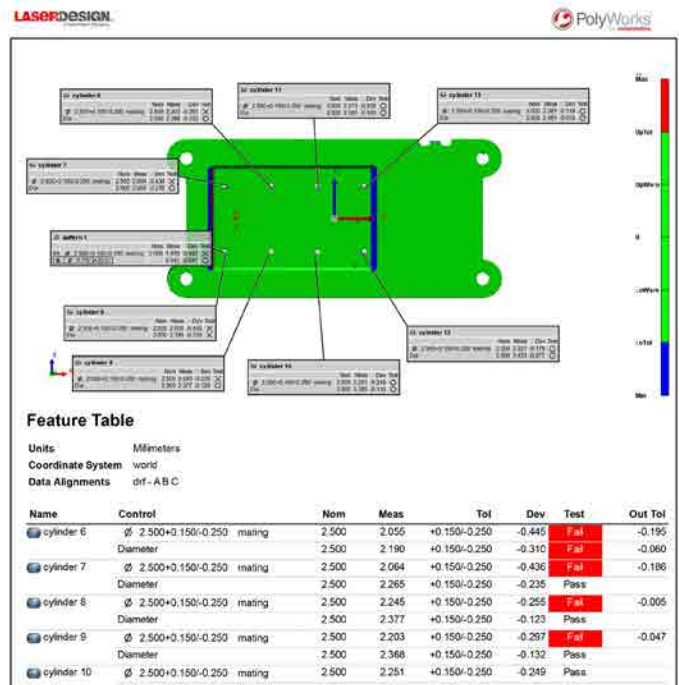
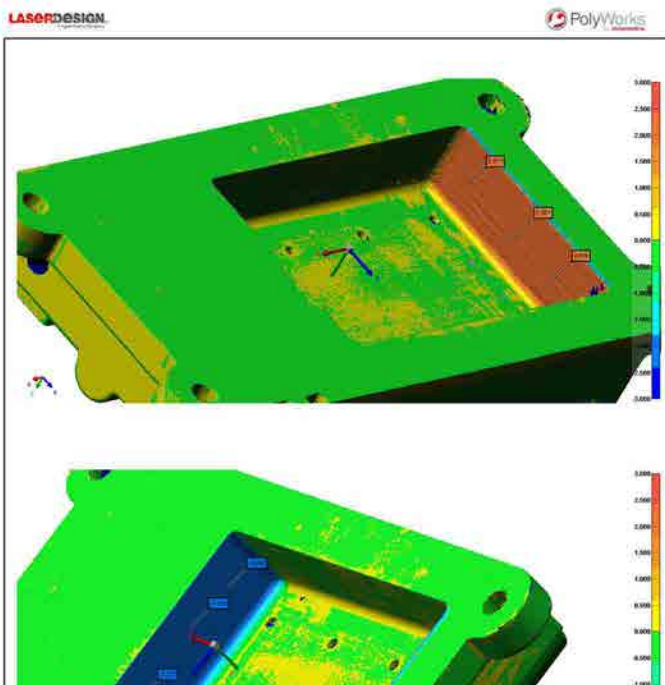

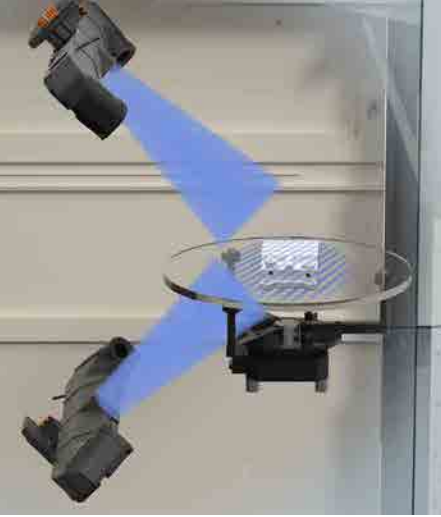

3D Scan Inspection – Simple as...

1

Open the door

2

Place the part

3

Press the button

Designed for use in general purpose metrology, the CyberGage360 has a range of applications from medical to automotive to aerospace where high accuracy and high speed throughput are important.

Specifications

Work Volume	200mm diameter x 100mm high cylinder (8" diameter x 4" high)
Sensor Technology	Patented MRS technology with structured blue light
System Volumetric Accuracy	7 µm; 0.007mm +L/10000mm (ISO 10360) See Accuracy Statement for CyberGage360 report available at LaserDesign.com/Products/CyberGage360
Repeatability	5 µm; 0.005mm See Accuracy Statement for CyberGage360 report available at LaserDesign.com/Products/CyberGage360
Speed	Up to 16 million points/part/pose. Typical cycle time < 3 minutes
CDRH Safety	Eye safe - no protection needed
System Controllers Embedded	High-performance PC included
Environmental Temperature	Temperature ambient = 20°C +/- 3°C (68.5°F +/- 5°F) to maintain calibrated performance
Operating Environment	Humidity 50% +/- 30%
Weight of Part	2.0 kg max (4.4 lbs.)
Data Output Formats	STL, PLY, OBJ, ASC
Electrical Requirements	100-240 VAC, 3.6/1.8 Amps, 60-50Hz, Phase 1
Included with System	PC controller built in, Polyworks Inspector inspection reporting software with: 1 year maintenance/updates/support, operation manual, maintenance manual, and training at factory (Minneapolis or onsite option).
Warranty	1-year warranty (hardware, software, parts, labor, workmanship)

Dimensions

